

MAINTENANCE REMINDER SHEET

D110 with 42" Deck

Tractor

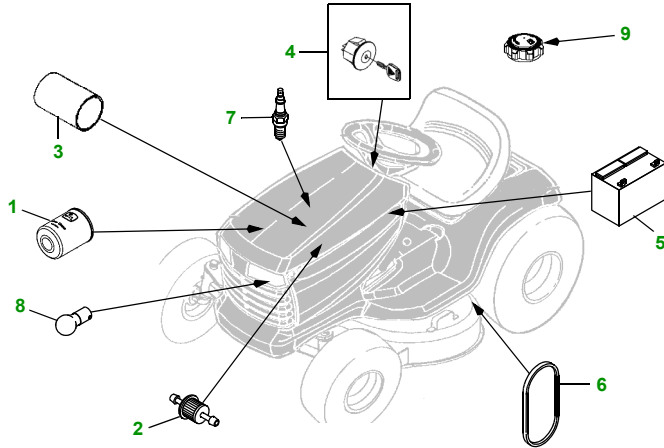

Tractor S/N

42" Deck

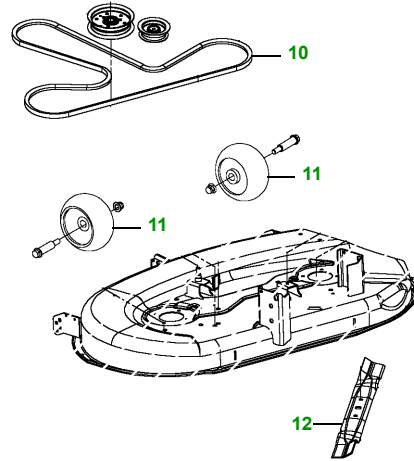

Deck S/N

Key	Part No.	Description
1	AM125424	OIL FILTER
2	AM116304	FUEL FILTER - IN-LINE
	GY20709	FUEL FILTER (PACKAGE)
3	MIU13038	AIR FILTER KIT (PACKAGE)
4	GY20680	KEY (PACKAGE)
	GY20074	IGNITION SWITCH
5	TY25878	BATTERY
6	GX20006	BELT - TRACTION DRIVE
7	M78543	SPARK PLUG — 49 STATE
	MIU11020	SPARK PLUG — 50 STATE

Key	Part No.	Description
8	AD2062R	HEADLIGHT BULB
9	GX23465	FUEL CAP
10	GX20072	BELT (PACKAGE)
11	GX10168	GAGE WHEEL
12	GX22151	3N1 BLADE - STANDARD
	GY20850	BLADE (PKG) (PACKAGE QTY - 2 BLADES)
	AM141034	KIT - HIGH LIFT BAGGING BLADE
	AM141033	KIT - MULCHING BLADE

Service Recommendations

"As Needed" Parts

Qty	Part No	Item	Qty or Capacity	Change Interval in Hours
6	AM125424	Oil Filter		8/50/100/150/200/250
1	TY22076	2 1/2 Gal. Engine Oil Turf Gard ® 10W30	1.5 qt	8/50/100/150/200/250
	MIU13038	Air Filter		50/100/150/200/250
	GY20709	Fuel Filter - Package		50/100/150/200/250
	M78543 or MIU11020	Spark Plug	1	50/100/150/200/250
2	TY6341	JD Multi Purpose SD Polyurea Grease		As Needed

Qty	Part No	Item
1	AM130907	Mower Deck Leveling Gauge
1	TY26183	Grease Gun

FOR ON-LINE PARTS ASSISTANCE:

: www.JDParts.Deere.com



- VIEW [John Deere Parts Catalog](#) to look-up part num-
- ORDER parts on-line from your [John Deere Dealer](#)
- SEARCH for parts for [YOUR specific model](#)
- SEARCH for parts by [Partial Part Number](#)

: www.Deere.com

- PRINT [Valuable Parts Coupons](#) for discounts at your John Deere.
- REVIEW John Deere [Parts Quality Stories](#)
- SEE a complete list of all [Home Maintenance Kits](#)
- CONSIDER [Quick Reference Guides](#) for your commercial equipment

FOR ON-LINE SERVICE ASSISTANCE:

: www.Deere.com

- VIEW [Technical \(Service\) Publications and Operator's Manuals](#)
- SELECT the desired [Maintenance Plan](#) that is right for you
- UNDERSTAND the [John Deere Warranty](#) on your equipment

OTHER SITES:

- SEARCH [Home & Workshop Products](#) off the Residential section at
- GO TO www.johndeerecredit.com to find your finance solution
- FIND the mower that is right for you through our [JD Mower Selection](#)
- GO TO www.johndeeregifts.com to stop by John Deere's "General Store"

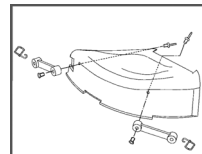

Mulch Cover Kit..... GY00115 (PACKAGE)

Dealer Name
Contact Name
Dealer Phone No



Home Maintenance Kit

Unit	Kit Number
D110	N/A

